

DISTILLATION APPARATUS



Distillation Column, Vacuum Jacketed

With standard taper top outer joint and bottom inner joint

Cat.No	Jacket Length (mm)	Joint
1053-1514	150	14/20
1053-1519	150	19/22
1053-2019	200	19/22
1053-2524	250	24/40

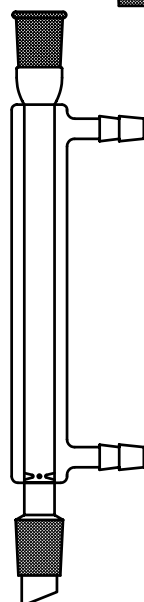

Distillation Column, Water Jacketed

With standard taper top outer joint and bottom inner joint

Cat.No	Jacket Length (mm)	Joint
1054-1514	150	14/20
1054-2014	200	14/20
1054-1519	150	19/22
1054-2019	200	19/22
1054-2024	200	24/40
1054-3024	300	24/40

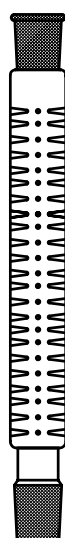

Distillation Column, Vigreux

With standard taper top outer joint and bottom inner joint

Cat.No	Jacket Length (mm)	Joint
1055-7514	75	14/20
1055-1014	100	14/20
1055-1514	150	14/20
1055-1019	100	19/22
1055-1519	150	19/22
1055-1524	150	24/40
1055-2024	200	24/40
1055-3024	300	24/40
1055-4029	400	29/42
1055-5029	500	29/42
1055-6029	600	29/42

DISTILLATION APPARATUS

Distilling Head, Short Path

10/18 joint for 25mm immersion and 14/20 joint for 51mm immersion

Cat.No	Top Themometer Joint	Joint
1056-1014	10/18	14/20
1056-1019	10/18	19/22
1056-1424	14/20	24/40

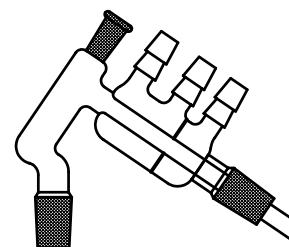

Distilling Head, Short Path Vigreux

10/18 joint for 25mm immersion and 14/20 joint for 51mm immersion

Cat.No	Top Themometer Joint	Joint
1057-1014	10/18	14/20
1057-1019	10/18	19/22
1057-1424	14/20	24/40

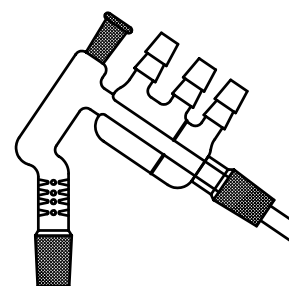

Distilling Head, Short Path Vacuum Jacketed

10/18 joint for 25mm immersion and 14/20 joint for 51mm immersion

Cat.No	Top Themometer Joint	Joint
1058-1014	10/18	14/20
1058-1019	10/18	19/22
1058-1424	14/20	24/40

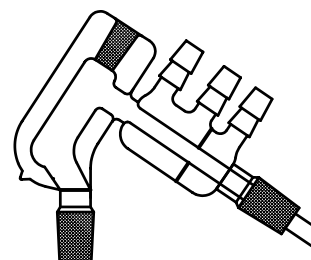

Distilling Head, Short Path Vigreux Vacuum Jacketed

10/18 joint for 25mm immersion and 14/20 joint for 51mm immersion

Cat.No	Top Themometer Joint	Joint
1059-1014	10/18	14/20
1059-1019	10/18	19/22
1059-1424	14/20	24/40

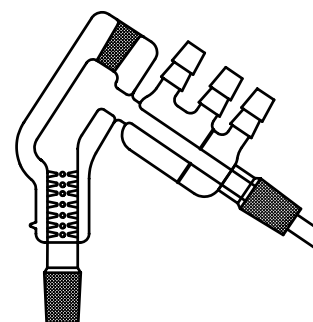

DISTILLATION APPARATUS

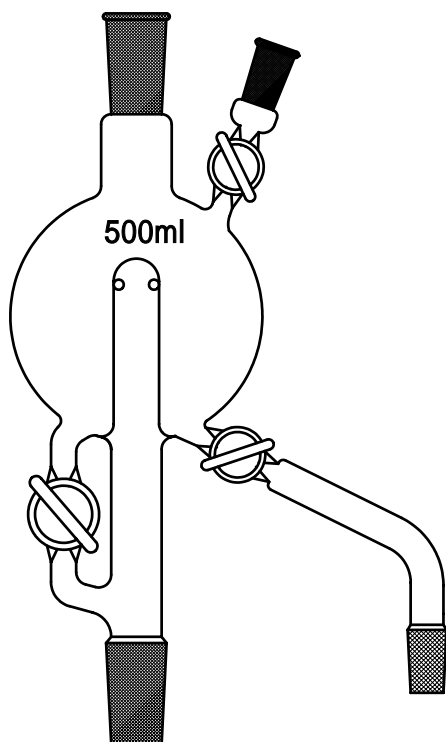

Distillation Head, Solvent, Teflon Stopcock

With standard taper top outer joint and bottom inner joint

Cat.No	Capacity ml	Joint	
		Top Bottom	Joint Side
1060-2403	300	24/40	14/20
1060-2405	500	24/40	14/20
1060-2910	1000	29/42	14/20

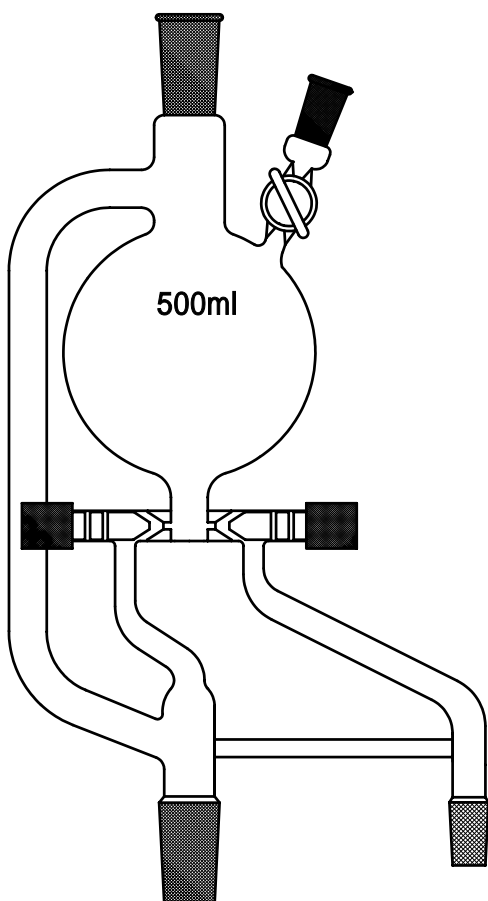

Distillation Head, Solvent, High Vacuum Valve

With standard taper top outer joint and bottom inner joint

Cat.No	Capacity ml	Joint	
		Top Bottom	Joint Side
1061-2403	300	24/40	14/20
1061-2405	500	24/40	14/20
1061-2910	1000	29/42	14/20

DISTILLATION APPARATUS

Distilling Head, Solvent

With standard taper top outer joint and bottom inner joint

Cat.No	Capacity ml	Joint Top	Joint Bottom
1062-1403	30	14/20	14/20
1062-1405	50	14/20	14/20
1062-1910	100	19/22	19/22

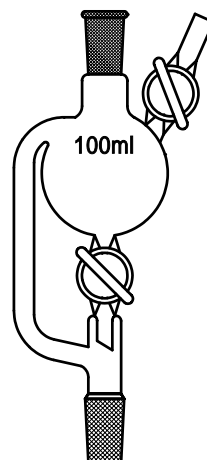

Distilling Head, Short Path

Top Thermometer 10/18 joint for 76mm immersion

Cat.No	Jacket Length(mm)	Joint Bottom	Joint Side
1063-4150	150	14/20	14/20
1063-4250	250	24/40	14/20
1063-2350	350	29/42	14/20

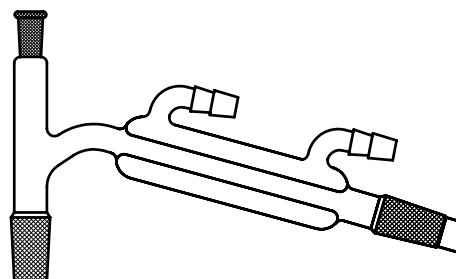

Distilling Head, Short Path

Thermometer 10/18 joint for 25mm immersion

Cat.No	Jacket Length(mm)	Joint Top/Bottom	Joint Side
1064-4150	150	14/20	14/20
1064-4200	200	19/22	14/20

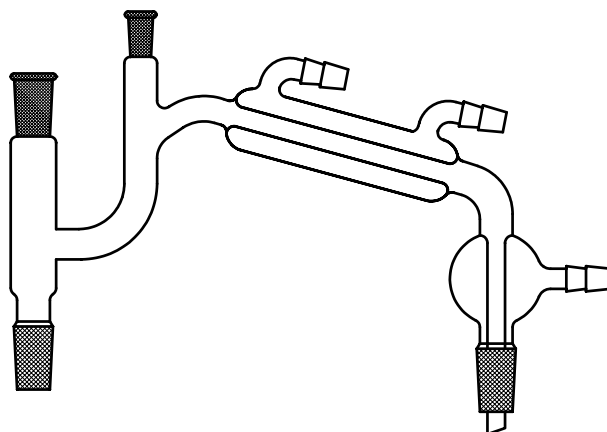

Adapter, Evacuation/Purging

Used with delivery port

Cat.No	Joint Top	Joint Bottom
10AD-1420	14/20	14/20
10AD-1419	14/20	19/22

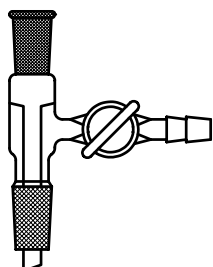

DISTILLATION APPARATUS

Distillation Receiver, Without Hose Connection

Cow type with three receivers 45 ° apart

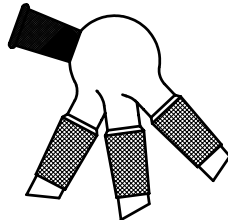

Cat.No	Joint Side	Joint Bottom
1065-1420	14/20	14/20
1065-1922	19/22	19/22
1065-1914	19/22	14/20
1065-2419	24/40	19/22
1065-2440	24/40	24/40

Distillation Receiver, With Hose Connection

Cow type with three receivers 45 ° apart

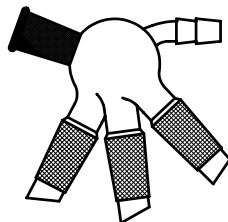

Cat.No	Joint Side	Joint Bottom
1066-1420	14/20	14/20
1066-1922	19/22	19/22
1066-1914	19/22	14/20
1066-2419	24/40	19/22
1066-2440	24/40	24/40

Distillation Receiver, Cow Type

With one outer joint and four drip joints

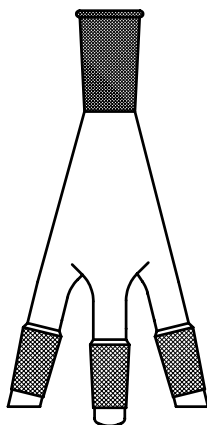

Cat.No	Joint Top	Joint Bottom
1067-1420	14/20	14/20
1067-1922	19/22	19/22
1067-1914	19/22	14/20
1067-2419	24/40	19/22
1067-2440	24/40	24/40

DISTILLATION APPARATUS

Distilling Receiver

Top inner joint and four inner joint tip

Cat.No	Joint Top	Joint Bottom
1068-1420	14/20	14/20
1068-1922	19/22	19/22
1068-1914	19/22	14/20
1068-2419	24/40	19/22
1068-2440	24/40	24/40

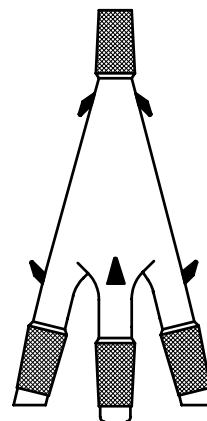

Distilling Receiver, Graduated

With hooks

Cat.No	Joint Top	Capacity ml
1068-1412	14/20	12
1068-1415	14/20	15
1068-1912	19/22	12
1068-1915	19/22	15



Distilling Adapter

Top and Bottom outer joint with hooks

Cat.No	Joint Top	Joint Bottom
1069-1420	14/20	14/20
1069-1922	19/22	19/22
1069-2440	19/22	14/20

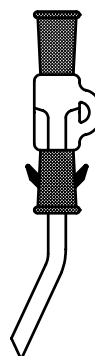

Distilling Adapter

With hose connection

Cat.No	Joint Top	Joint Bottom
1070-1420	14/20	14/20
1070-1922	19/22	19/22
1070-2440	19/22	14/20

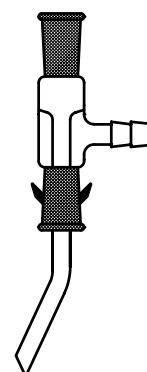

Distilling Adapter 105 °

Top and bottom outer joint with hooks

Cat.No	Joint Top	Joint Bottom
1071-1420	14/20	14/20
1071-1922	19/22	19/22
1071-2440	19/22	14/20

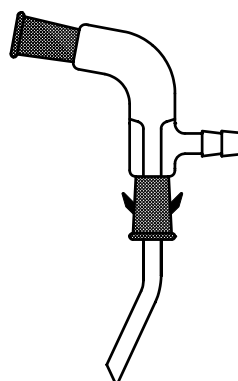

DISTILLATION APPARATUS

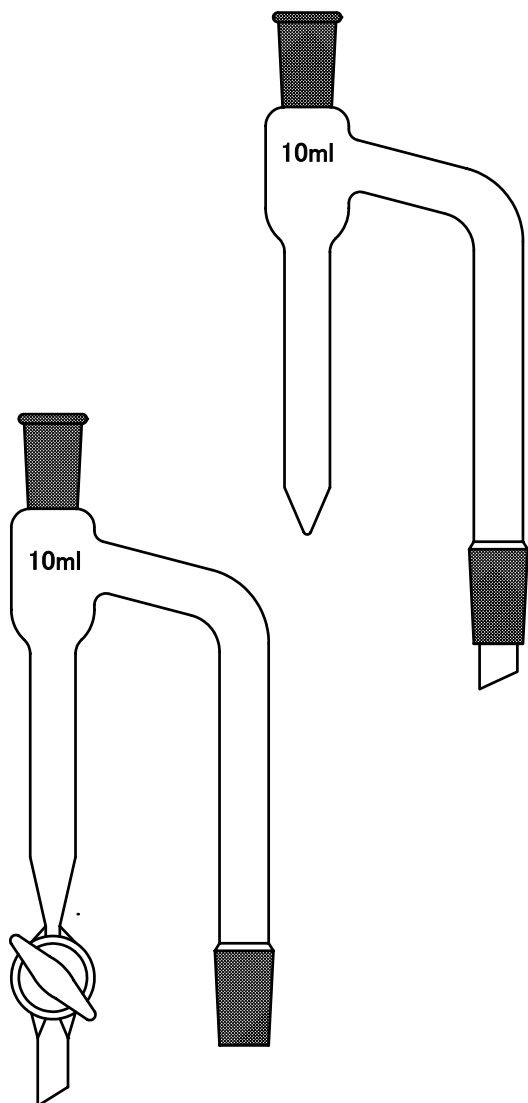

**Distilling Receiver, Moisture Test
Dean & Stark**

Cat.No	Capacity ml	Joint
1072-1410	10	14/20
1072-1425	25	14/20
1072-2410	10	24/40
1072-2425	25	24/40

**Distilling Receiver, Moisture Test
Dean&Stark Glass Stopcock**

Cat.No	Capacity ml	Joint
1073-1402	2	14/20
1073-1405	5	14/20
1073-1410	10	14/20
1073-2410	10	24/40
1073-2420	20	24/40

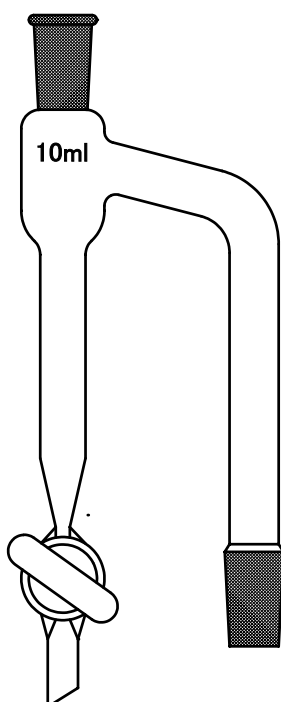

**Distilling Receiver, Moisture Test
Dean&Stark tefion Stopcock**

Cat.No	Capacity ml	Joint
1074-1402	2	14/20
1074-1405	5	14/20
1074-1410	10	14/20
1074-1902	2	19/22
1074-1905	5	19/22
1074-1910	10	19/22
1074-2410	10	24/40
1074-2420	20	24/40

DISTILLATION APPARATUS

Distilling Receiver, Moisture Test Dean & Stark

Cat.No	Capacity ml	Joint
1075-1410	10	14/20
1075-1425	25	14/20
1075-2410	10	24/40
1075-2425	25	24/40

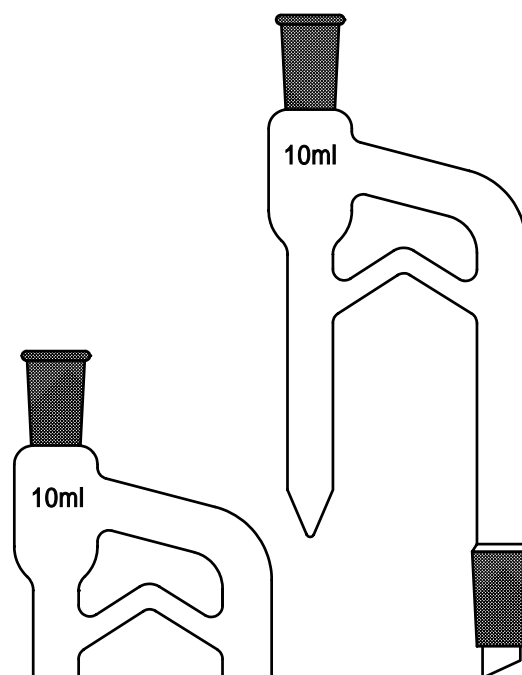

Distilling Receiver, Moisture Test Dean & Stark Tefion Stop cock

Cat.No	Capacity ml	Joint
1076-1410	10	14/20
1076-1425	25	14/20
1076-2410	10	24/40
1076-2425	25	24/40

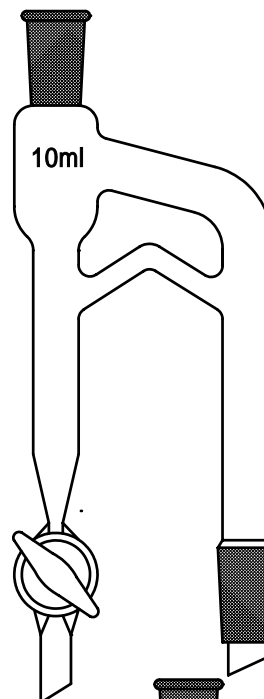

Distilling Receiver, Moisture Test Dean & Stark Teflon Stop cock

Cat.No	Capacity ml	Joint
1077-1405	5	14/20
1077-1420	20	19/22

