

ADAPTERS CONNECTING

Adapter , Connecting , Reducing
Bottom inner joint is larger size than the top outer joint



Cat.No	Top joint Outer Joint	Bottom Joint Inner Joint
1101-1014	10/30	14/20
1101-1019	10/30	19/22
1101-1024	10/30	24/40
1101-1029	10/30	29/42
1101-1419	14/20	19/22
1101-1424	14/20	24/40
1101-1429	14/20	29/42
1101-1924	19/22	24/40
1101-1929	19/22	29/42
1101-2429	24/40	29/42
1101-2434	24/40	34/45
1101-2445	24/40	45/50
1101-2934	29/42	34/45
1101-2945	29/42	45/50

Adapter , Connecting , Enlarging
Bottom inner joint is smaller in size than the top outer joint

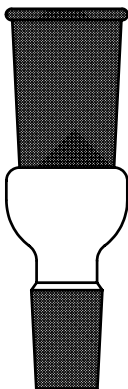

Cat.No	Top joint Outer Joint	Bottom Joint Inner Joint
1102-1410	14/20	10/30
1102-1910	19/22	10/30
1102-1914	19/22	14/20
1102-2410	24/40	10/30
1102-2414	24/40	14/20
1102-2419	24/40	19/22
1102-2910	29/42	10/30
1102-2914	29/42	14/20
1102-2919	29/42	19/22
1102-2924	29/42	24/40
1102-3424	34/45	24/40
1102-3429	34/45	29/42
1102-4524	45/50	24/40
1102-4529	45/50	29/42

ADAPTERS CONNECTING

Adapter , Bushing

A bottom inner joint and top outer joint ground in the bore of the adapter

Cat.No	Top joint Outer Joint	Bottom Joint Inner Joint
1103-1014	10/20	14/20
1103-1019	10/20	19/22
1103-1024	10/30	24/40
1103-1419	14/20	19/22
1103-1424	14/35	24/40
1103-1429	14/35	29/42
1103-1924	19/38	24/40
1103-1929	19/38	29/42

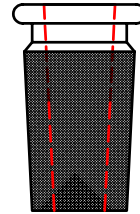

Adapter , Connecting , Combination

With top spherical socket joint and bottom inner joint

Cat.No	Top joint Socket Joint	Bottom Joint Inner Joint
1104-3514	35/20	14/20
1104-3519	35/20	19/22
1104-3524	35/20	24/40
1104-3529	35/20	29/42

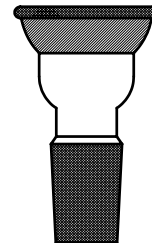

Adapter , Connecting , Combination

With top outer joint and bottom spherical ball joint

Cat.No	Top joint Outer Joint	Bottom Joint Ball Joint
1105-1435	14/20	35/20
1105-1935	19/22	35/20
1105-2435	24/40	35/20
1105-2935	29/42	35/20

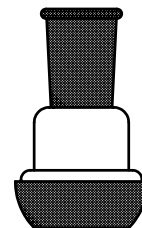

ADAPTERS CONNECTING

Adapter , Connecting ,Straight

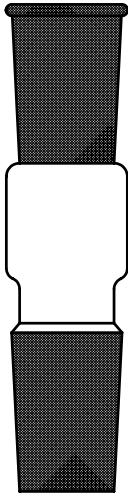

Cat.No	Joint Size	Length Between Joint mm
1106-1430	14/20	30
1106-1490	14/20	90
1106-1930	19/22	30
1106-1029	19/22	60
1106-1990	19/22	90
1106-2430	24/40	30
1106-2470	24/40	70
1106-2412	24/40	120
1106-2418	24/40	180
1106-2930	29/42	30
1106-2970	29/42	70
1106-2912	29/42	120
1106-2918	29/42	180

Adapter , Connecting ,Straight

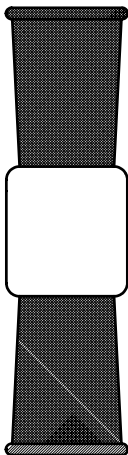

Cat.No	Joint Size	Length Between Joint mm
1107-1430	14/20	30
1107-1490	14/20	90
1107-1930	19/22	30
1107-1960	19/22	60
1107-1990	19/22	90
1107-2430	24/40	30
1107-2470	24/40	70
1107-2412	24/40	120
1107-2418	24/40	180
1107-2930	29/42	30
1107-2970	29/42	70
1107-2912	29/42	120
1107-2918	29/42	180

Adapter , Connecting ,Straight

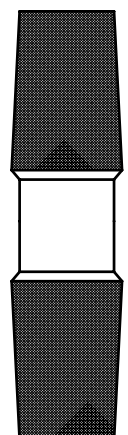

Cat.No	Joint Size	Length Between Joint mm
1108-1430	14/20	30
1108-1490	14/20	90
1108-1930	19/22	30
1108-1960	19/22	60
1108-1990	19/22	90
1108-2430	24/40	30
1108-2470	24/40	70
1108-2412	24/40	120
1108-2418	24/40	180
1108-2930	29/42	30
1108-2970	29/42	70
1108-2912	29/42	120
1108-2918	29/42	180

ADAPTERS INLET

Adapter , inlet , inner joint , 90 °

With standard taper inner joint and hose connection

Cat.No	Joint Size	Hose O.D. mm
1109-1420	14/20	10
1109-1922	19/22	10
1109-2440	24/40	10
1109-2942	29/42	10

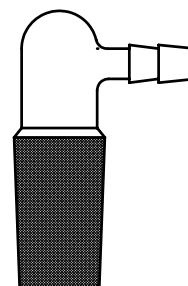

Adapter , inlet , Ball joint , 90 °

With ball joint and hose connection

Cat.No	Ball joint Size	Hose O.D. mm
1109-BJ35	35/20	10

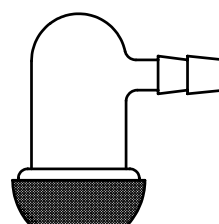

Adapter , inlet , inner joint

With standard taper inner joint and hose connection

Cat.No	Joint Size	Hose O.D. mm
1110-1420	14/20	10
1110-1922	19/22	10
1110-2440	24/40	10
1110-2942	29/42	10

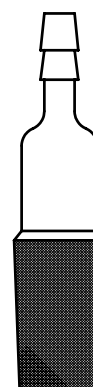

Adapter , inlet , with fritted disc

With standard taper inner joint and hose connection, and coarse fritted disc

Cat.No	Joint Size	Hose O.D. mm
1111-1420	14/20	10
1111-1922	19/22	10
1111-2440	24/40	10
1111-2942	29/42	10



Adapter , inlet , outer joint

Cat.No	Joint Size	Hose O.D. mm
1112-1420	14/20	10
1112-1922	19/22	10
1112-2440	24/40	10
1112-2942	29/42	10

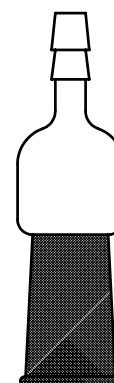

ADAPTERS INLET

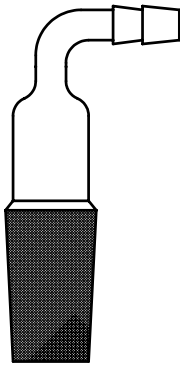

Adapter , inlet , inner joint , 90 °

With standard taper inner joint and hose connection

Cat.No	Joint Size	Hose O.D. mm
1113-1420	14/20	10
1113-1922	19/22	10
1113-2440	24/40	10
1113-2942	29/42	10

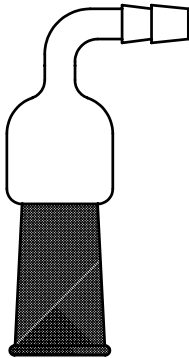

Adapter , inlet , outer joint , 90 °

With standard taper inner joint and hose connection

Cat.No	Joint Size	Hose O.D. mm
1114-1420	14/20	10
1114-1922	19/22	10
1114-2440	24/40	10
1114-2942	29/42	10

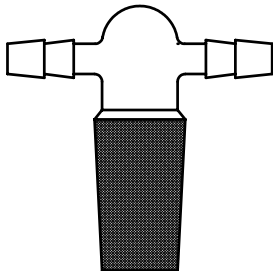

Adapter , inlet , inner joint

With standard taper inner joint and hose connection

Cat.No	Joint Size	Hose O.D. mm
1115-1420	14/20	10
1115-1922	19/22	10
1115-2440	24/40	10
1115-2942	29/42	10

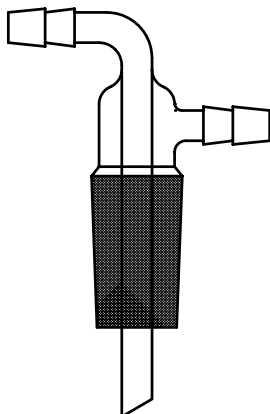

Adapter , inlet , inner joint

With standard taper inner joint and hose connection

Cat.No	Joint Size	Hose O.D. mm
1116-1420	14/20	10
1116-1922	19/22	10
1116-2440	24/40	10
1116-2942	29/42	10

ADAPTERS FLOW CONTROL

Adapter , Flow control , Glass stopcock

With standard taper inner joint and hose connection

Cat.No	Joint Size	Hose O.D. mm
1117-1420	14/20	10
1117-1922	19/22	10
1117-2440	24/40	10
1117-2942	29/42	10



Adapter , Flow control , Teflon stopcock

With standard taper inner joint and hose connection

Cat.No	Joint Size	Hose O.D. mm
1118-1420	14/20	10
1118-1922	19/22	10
1118-2440	24/40	10
1118-2942	29/42	10

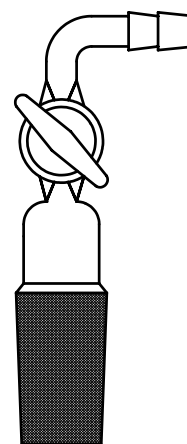

Adapter , Flow control , Glass stopcock 90 °

With standard taper inner joint and hose connection

Cat.No	Joint Size	Hose O.D. mm
1119-1420	14/20	10
1119-1922	19/22	10
1119-2440	24/40	10
1119-2942	29/42	10

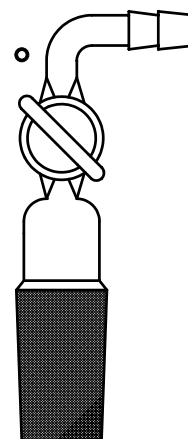

Adapter , Flow control , Teflon stopcock 90 °

With standard taper inner joint and hose connection

Cat.No	Joint Size	Hose O.D. mm
1120-1420	14/20	10
1120-1922	19/22	10
1120-2440	24/40	10
1120-2942	29/42	10

ADAPTERS FLOW CONTROL

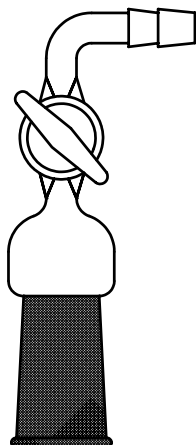

Adapter , Flow Control , Glass Stopcock , 90°
With standard taper outer joint and hose connection

Cat.No	Joint Size	Hose O.D. mm
1121-1420	14/20	10
1121-1922	19/22	10
1121-2440	24/40	10
1121-2942	29/42	10

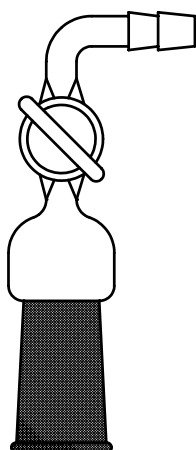

Adapter , Flow Control , Teflon Stopcock , 90°
With standard taper outer joint and hose connection

Cat.No	Joint Size	Hose O.D. mm
1122-1420	14/20	10
1122-1922	19/22	10
1122-2440	24/40	10
1122-2942	29/42	10



Adapter , Flow Control , Teflon Stopcock
With standard taper outer joint and hose connection

Cat.No	Top joint Outer Joint	Bottom Joint Inner Joint
1123-1414	14/20	14/20
1123-1419	14/20	19/22
1123-1424	14/20	24/40
1123-1429	14/20	29/42
1123-1919	19/22	19/22
1123-1924	19/22	24/40
1123-1929	19/22	29/42
1123-2424	24/40	24/40
1123-2429	24/40	29/42
1123-2929	29/42	29/42

ADAPTERS FLOW CONTROL

Adapter , Vacuum Filtration , Teflon , stopcock

With standard taper of top outer joint and bottom inner joint and hose connection

Cat.No	Joint Size	Hose O.D. mm
1124-1420	14/20	10
1124-1922	19/22	10
1124-2440	24/40	10
1124-2942	29/42	10

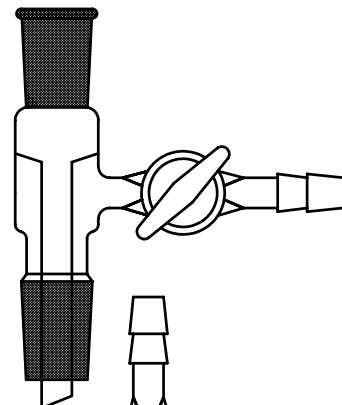

Adapter , Vacuum Transfer , Teflon , stopcock

With standard taper bottom inner joint and hose connection

Cat.No	Joint Size	Hose O.D. mm
1125-1420	14/20	10
1125-1922	19/22	10
1125-2440	24/40	10
1125-2942	29/42	10

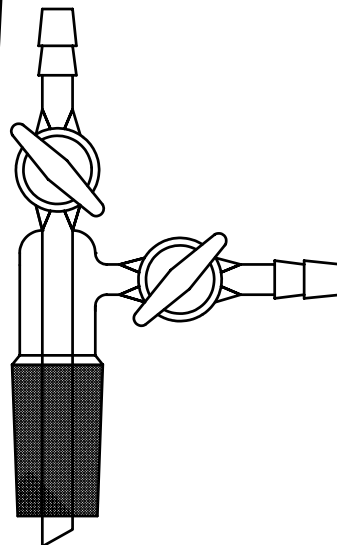

Adapter , Flushing , Teflon Stopcock

With standard taper inner joint and hose connection

Cat.No	Joint Size	Hose O.D. × Length
1126-1420	14/20	10 × 50
1126-1922	19/22	10 × 50
1126-2440	24/40	10 × 50
1126-2942	29/42	10 × 50

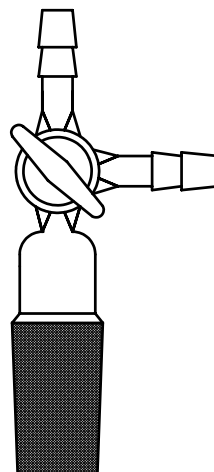

Adapter , Vacuum / Inert Gas , Teflon Stopcock

With standard taper inner joint and hose connection

Cat.No	Joint Size	Hose O.D. × Length
1127-1420	14/20	10 × 50
1127-1922	19/22	10 × 50
1127-2440	24/40	10 × 50
1127-2942	29/42	10 × 50

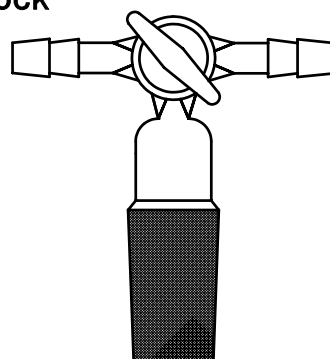

ADAPTERS DISTILLATION

Adapter , Bubbler

Cat.No	Body O.D. mm	Overall H.×W. mm
1128-8030	26	100×30
1128-1880	26	180×80

Adapter , Bubbler

Adverse current prevention valve

Cat.No	Body O.D. mm	Overall H.×W. mm
1129-8030	26	100×30
1129-1880	26	180×80

Adapter , Bubbler , Modified

AWith standard taper inner joint and hose connection

Cat.No	Joint Size	Hose O.D. mm
1130-1420	14/20	10
1130-1922	19/22	10
1130-2440	24/40	10

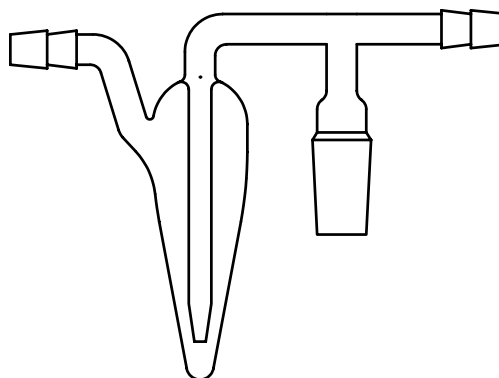
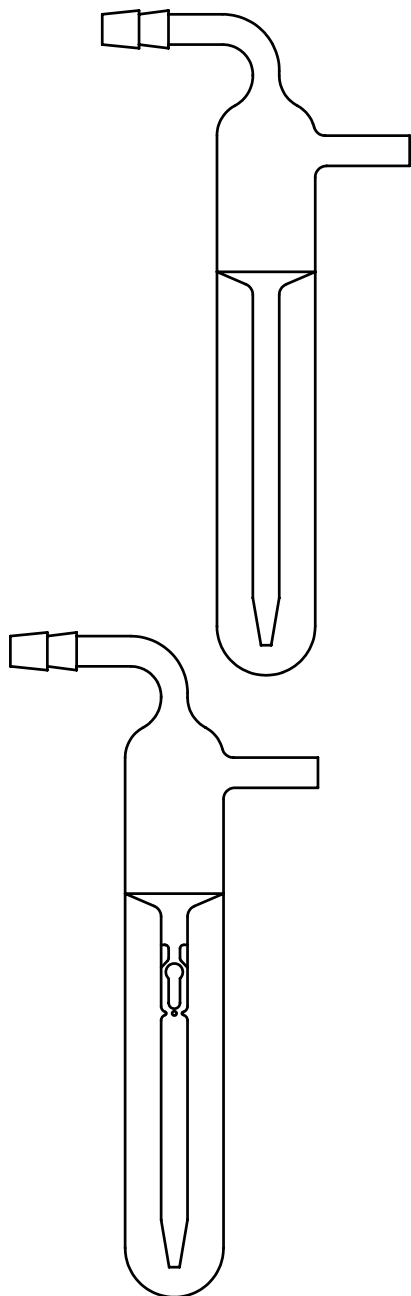

ADAPTERS DISTILLATION

Adapter ,Distillation , 105°

With standerd taper outer joint

Cat.No	Joint Size	O.D. mm
1131-1420	14/20	8
1131-1922	19/22	8
1131-2440	24/40	10
1131-2942	29/42	10

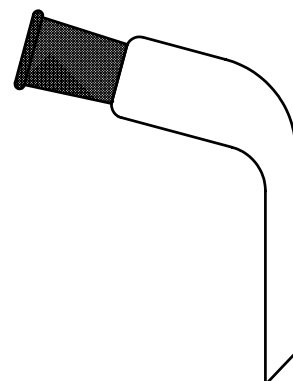

Adapter ,Distillation , 105°

With standard taper top puter joint and bottom inner joint

Cat.No	Top joint Outer Joint	Bottom Joint Inner Joint
1132-1414	14/20	14/20
1132-1419	14/20	19/22
1132-1424	14/20	24/40
1132-1429	14/20	29/42
1132-1919	19/22	19/22
1132-1924	19/22	24/40
1132-1929	19/22	29/42
1132-2424	24/40	24/40
1132-2929	29/42	29/42

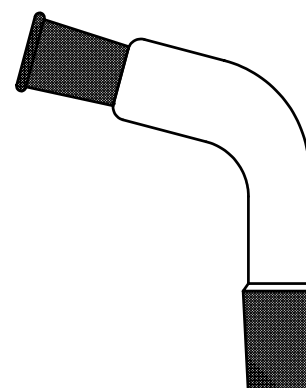

Adapter ,Distillation , 105°

With standard taper top puter joint and bottom inner joint

Cat.No	Top joint Outer Joint	Bottom Joint Inner Joint
1133-1414	14/20	14/20
1133-1419	14/20	19/22
1133-1424	14/20	24/40
1133-1429	14/20	29/42
1133-1919	19/22	19/22
1133-1924	19/22	24/40
1133-1929	19/22	29/42
1133-2929	29/42	29/42

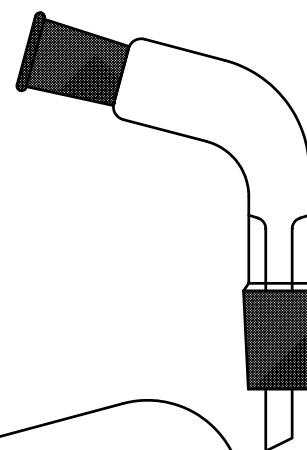

Adapter ,Distillation , 75°

With standard taper inner joint

Cat.No	Top joint Outer Joint	Bottom Joint Inner Joint
1134-1420	14/20	14/20
1134-1922	19/22	19/22
1134-2440	24/40	24/40
1134-2942	29/42	29/42
1134-1424	14/20	24/40
1134-1924	19/22	24/40
1134-1429	14/20	29/42
1134-1929	19/22	29/42

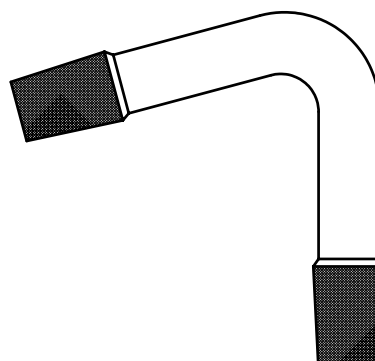

ADAPTERS DISTILLATION

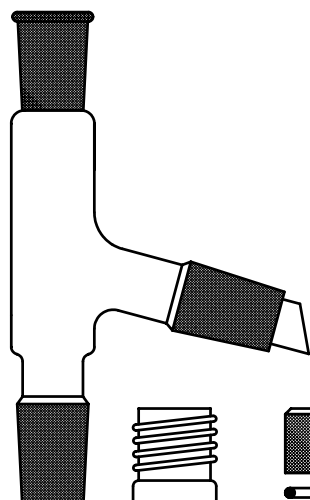

Adapter , Distillation Connecting

With standard taper joint and inner joint

Cat.No	Top & Bottom Outer . Inner Joint	Side Inner Joint
1135-1420	14/20	14/20
1135-1922	19/22	19/22
1135-2440	24/40	24/40
1135-2942	29/42	29/42

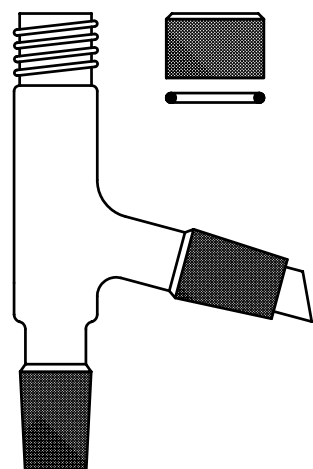

Adapter , Distillation Connecting

Top threaded thermometer port , Cap and #010 viton O-ring (for 6~7mm OD thermometer)

Cat.No	Bottom Inner Joint	Side Inner Joint
1136-1414	14/20	14/20
1136-1919	19/22	19/22
1134-2414	24/40	14/20
1134-2419	24/40	19/22
1134-2424	24/40	24/40
1134-2929	29/42	29/42

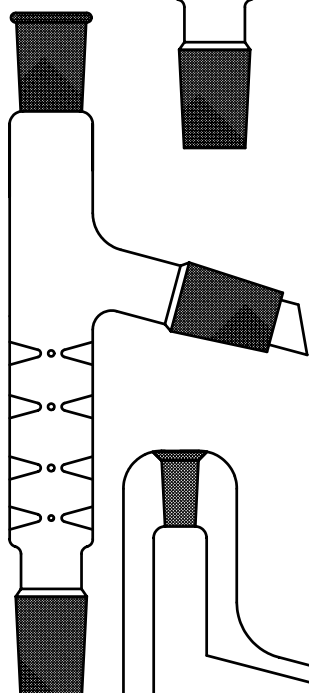

Adapter , Distillation Connecting , Vigreux

Top With standard taper 10/30 top outer joint for 75mm immersion thermometers and the same size inner joints on the bottom and sidearm

Cat.No	Bottom Outer Joint	Side Inner Joint
1137-1414	14/20	14/20
1137-2440	24/40	24/40

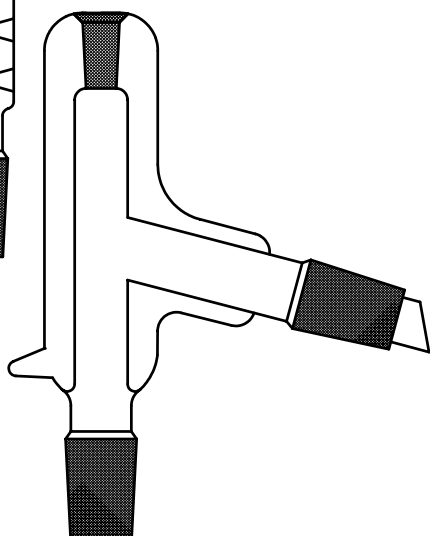

Adapter , Distillation Connecting , Vacuum Jacketed

Top With standard taper 10/30 top outer joint for 75mm immersion thermometers and the same size inner joints on the bottom and sidearm

Cat.No	Bottom Inner Joint	Side Inner Joint
1138-1414	14/20	14/20

ADAPTERS DISTILLATION

Adapter ,Distillation , Connecting

The top of the side tube is threaded thermometer port , supplied complete with cap and #010 viton O-ring(for 6 ~ 7mm OD thermometer) sidearm has a standard taper inner drip tip joint while vertical tube has top outer and bottom inner joints , all being the same size

Cat.No	Top & Bottom		Side Inner Joint
	Outer	Inner Joint	
1139-1420	14/20		14/20
1139-1922	19/22		19/22
1139-2440	24/40		24/40
1139-2942	29/42		29/42

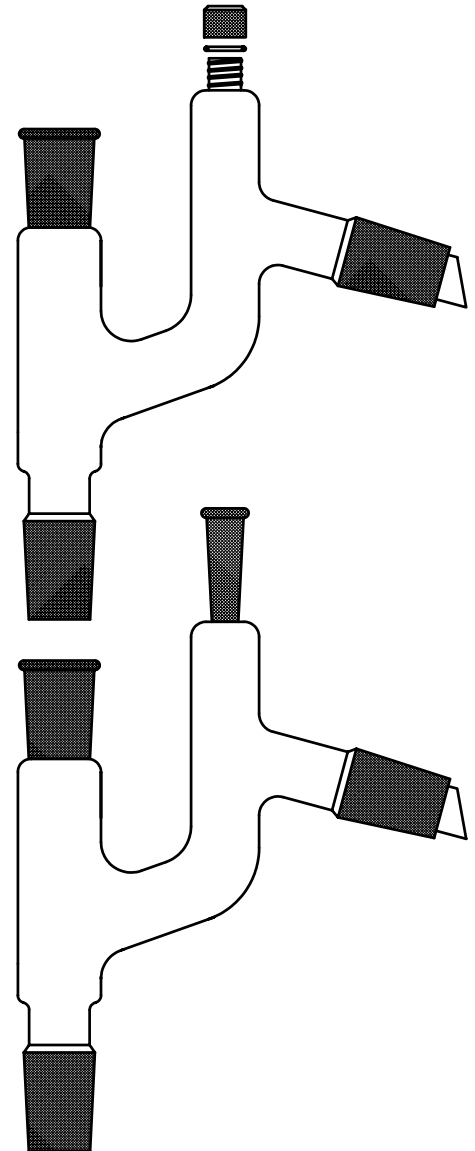

Adapter ,Distillation , Connecting

The top of the side tube is 10/30 top outerjoint for 75mm immersion thermometers , sidearm has a standard taper inner drip tip jointe while vertical tube has top outer and bottom inner joints , all being the same size

Cat.No	Top & Bottom		Side Inner Joint
	Outer	Inner Joint	
1140-1420	14/20		14/20
1140-1922	19/22		19/22
1140-2440	24/40		24/40
1140-2942	29/42		29/42

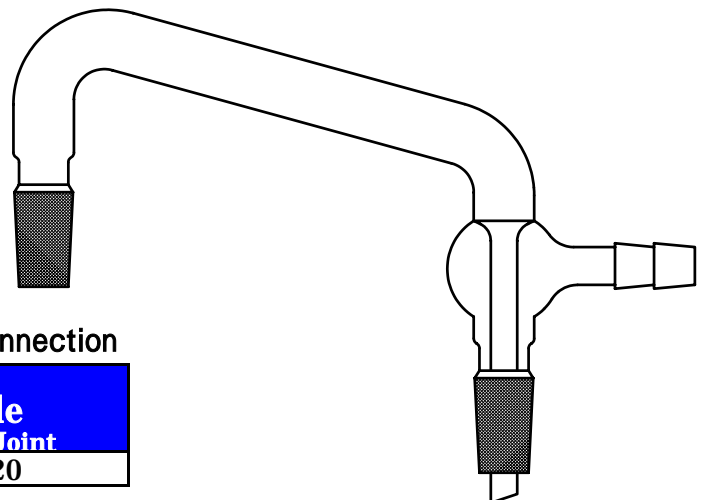

Adapter ,Distillation , Vacuum

TWith standard taper inner joint and hose connection

Cat.No	Bottom		Side Inner Joint
	Outer	Joint	
1141-1420	14/20		14/20

ADAPTERS VACUUM

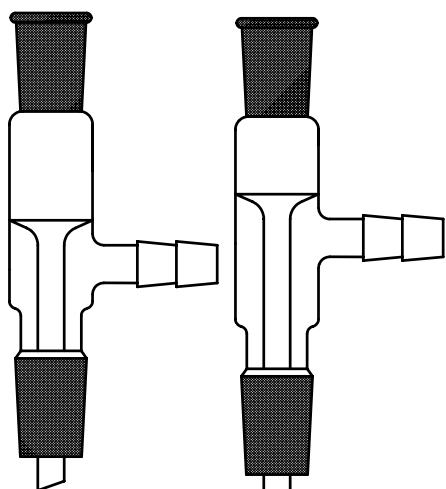

Adapter , Vacuum Take-off

With same size top outer and bottom inner joint

Cat.No	Top Outer Joint	Bottom Inner Joint
1142-1420	14/20	14/20
1142-1922	19/22	19/22
1142-2440	24/40	24/40
1142-2942	29/42	29/42

Adapter , Vacuum Take-off , Long stem

With same size top outer and bottom inner joint

Cat.No	Top Outer Joint	Bottom Inner Joint
1143-1420	14/20	14/20
1143-1922	19/22	19/22
1143-2440	24/40	24/40
1143-2942	29/42	29/42

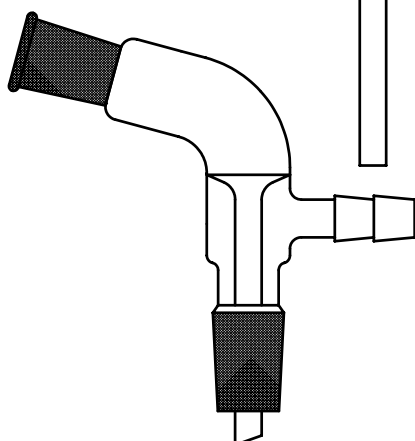

Adapter , Vacuum Take-off , 105°

With same size top outer and bottom inner joint

Cat.No	Top Outer Joint	Bottom Inner Joint
1144-1420	14/20	14/20
1144-1922	19/22	19/22
1144-2440	24/40	24/40
1144-2942	29/42	29/42

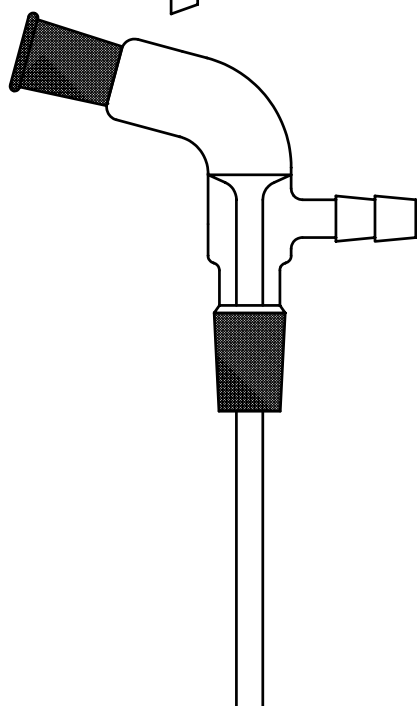

Adapter , Vacuum Take-off , Long stem 105°

With same size top outer and bottom inner joint

Cat.No	Top Outer Joint	Bottom Inner Joint
1145-1420	14/20	14/20
1145-1922	19/22	19/22
1145-2440	24/40	24/40
1145-2942	29/42	29/42

ADAPTERS

Adapter , Claisen

All standard taper inner joint and outer joint

Cat.No	Joint Size
1146-1420	14/20
1146-1922	19/22
1146-2440	24/40
1146-2942	29/42

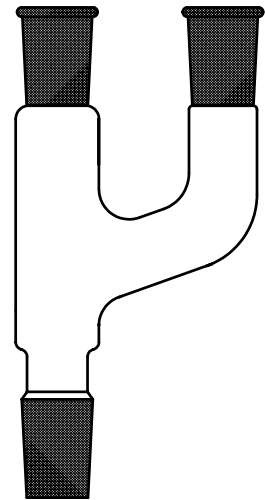

Adapter , Claisen , Modified

All standard taper inner joint and outer joint

Cat.No	Joint Size
1147-1420	14/20
1147-1922	19/22
1147-2440	24/40
1147-2942	29/42

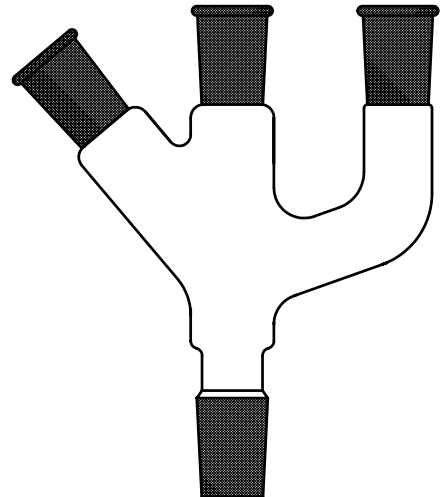

Adapter , Pour-out

With standard taper bottom inner joint

Cat.No	Joint Size
1148-1420	14/20
1148-1922	19/22
1148-2440	24/40
1148-2942	29/42

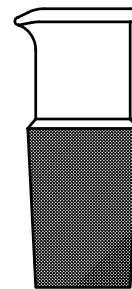

Adapter ,Direct drip

With standard taper top outer joint

Cat.No	Top Outer Joint	Bottom Inner Joint
1149-1420	14/20	14/20
1149-1922	19/22	19/22
1149-2440	24/40	24/40

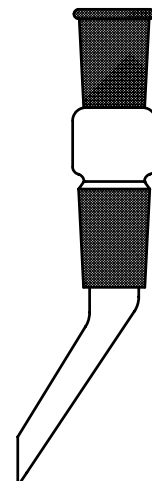

ADAPTERS

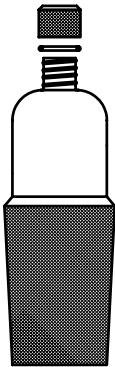

Adapter , Inlet or thermometer

With standard taper inner joint on the bottom , and the top is threaded thermometer port , supplied complete with cap and #010 viton o-ring (for 6 ~ 7mm OD thermometers)

Cat.No	Joint Size
1150-1420	14/20
1150-1922	19/22
1150-2440	24/40
1150-2942	29/42

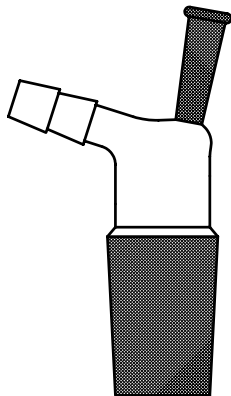

Adapter , Inlet or thermometer

With standard taper 10/30 top outer joint for 75mm immersion thermometers and bottom inner joint , hose connection O , D is 10mm

Cat.No	Joint Size
1151-1420	24/40

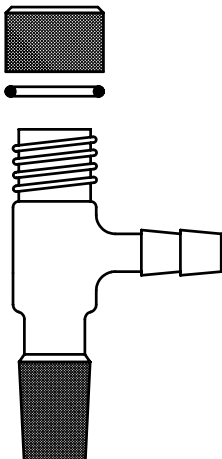

Adapter , Inlet or thermometer

With standard taper inner joint on the bottom , and the top is threaded thermometer port , supplied complete with cap and #010 viton o-ring (for 6 ~ 7mm OD thermometers) , hose connection O , D is 10mm

Cat.No	Joint Size
1152-1420	14/20
1152-1922	19/22
1152-2440	24/40
1152-2942	29/42